



PC20キャブレターキット 取扱説明書

商品番号 : 03-05-3201(キャブレターキット)
 : 03-02-052 (マニホールドセット)
適応車種 : モンキー/ゴリラ
フレーム番号: Z50J-1300017~
 AB27-1000001~

正しく安全にご使用頂く為に

この度は、弊社“モンキー/ゴリラPC20キャブレターキット”をお買い上げ頂きまして有難うございます。ご使用になられる前にこの説明書をよくお読みいただいて内容を把握下さいませお願い致します。

取り付け前には、必ずキット内容をお確かめ下さい。万一、お気付きの点がございましたらお買い求めいただいた販売店にご相談下さい。

当製品は、モンキー、ゴリラS-Stageキット専用となっております。STDエンジン及び他の車種には使用出来ませんのでご注意下さい。スタンダードスロットルハウジング使用時フレーム番号1300017~1510400までの車両は、スロットルバルブが全開にならない為、別売りのハイスロットルに変換するかスロットルパイプの加工が必要となります。(P.3加工図参照)又、上記フレーム番号の車両で遠心クラッチ車両は、同梱のスロットルケーブルが取り付け出来ません。別売りのハイスロットルに変換をお願い致します。

STDスロットルハウジングを使用の場合、STDスロットルケーブルから付属のハイスロットル用ケーブルに交換して下さい。

ハイスロットルを使用した場合STDスロットルハウジングを取り外す為フレーム番号Z50J-1300017~1510400までの車両は、フロントブレーキレバー及びウインカー、ホーンスイッチの使用が出来ません。又、フレーム番号Z50J-1600008以降の車両はフロントブレーキレバーの使用が出来ませんので別途ご用意下さい。(パワーレバー06-08-300が取り付け可能)

雨天時の走行は出来ません。ご注意下さい。

ブローパイガス還元装置付の車両(AB27-1000001~)は別途ブローパイガス還元装置対応のエアフィルター(03-01-110又は03-01-1105)を使用して下さい。

キャブレターは、使用部品や自然現象などによりセッティングが変化します。付属のジェットを基準とし、個々に合ったセッティングを行って下さい。

イラスト、写真などの記載内容が本パーツと異なる場合がありますので、予めご了承下さい。

特 徴

モンキー/ゴリラ用S-Stageキット専用に扱い易いキャブレターを設定し、STDスロットルハウジングを使用出来るようにハイスロットル用ケーブルをセットしました。取り付けは、ボルトオン(一部車種除く)で別売の削り出しファンネル・カールファンネル・エアフィルターが使用出来ます。

注意 この表示を無視した取り扱いをすると人が傷害を負う可能性が想定される内容及び物的傷害の発生が想定される内容を示しています。

- ・取り付け作業は必ずエンジン冷間時(35℃以下)に行なって下さい。エンジンやマフラーが冷えていない状態で作業を行なった場合、火傷の原因となります。
- ・ボルト、ナット類は、必ずトルクレンチを使用し指定トルクで確実に締め付けて下さい。
- ・キャブレターへのホース取り付けは、必ずホースクリップを用いて確実に接続して下さい。
- ・エンジン回転中は、キャブレター吸気管内を不用意に覗き込まないで下さい。吹き返しによるガソリンやバックファイヤーにより火災が噴出する場合があります。
- ・キャブレターは天候・気温・気圧の自然現象や使用部品の組み合わせ、個体差等によりセッティングを変更する必要があります。個々のエンジンに合ったセッティングを行なって下さい。
- ・走行前には必ず各部の取り付け状態やガソリン漏れを点検して下さい。又、走行中に異常が発生した場合は、直ちに車両を安全な場所へ停車させ異常箇所の点検を行なって下さい。

警告 この表示を無視した取り扱いをすると、人が死亡したり重傷を負う可能性が想定される内容を示しています。

- ・技術、知識等が無い方は、作業を行わないで下さい。(部品破損等の原因により、転倒、事故につながる恐れがあります。)
- ・走行前には、必ず各部の取り付け状態を点検し、緩み、ガソリンの漏れ等がないかを確認して下さい。又、走行中異常が発生した場合は、直ちに車両を安全な場所に停車させ異常箇所の点検を行って下さい。(そのまま、走行すると事故につながる恐れがあります。)
- ・エンジンを始動する場合は、必ず換気の良い場所で行って下さい。密閉した様な場所では、エンジンをかけないで下さい。(一酸化炭素中毒になる恐れがあります。)
- ・取り付け作業は、車両を安定させた状態で行って下さい。(車両が倒れてケガをする恐れがあります。)
- ・ガソリンは、非常に引火しやすい為、一切の火気を避け燃えやすい物が周りに無い事を確認して下さい。又、気化したガソリンの滞留は、爆発等の危険性がある為、通気の良い場所で作業を行って下さい。

性能アップ、デザイン変更、コストアップ等で製品および価格は予告無く変更されます。予めご了承下さい。

クレームについては、材料および加工に欠陥があると認められた製品に対してのみ、お買い上げ後1ヶ月以内を限度として、修理又は交換させて頂きます。但し、正しい取り付けや、使用方法など守られていない場合は、この限りではありません。修理又は交換等にかかる一切の費用は対象となりません。

なお、レース等でご使用の場合はいかなる場合もクレームは一切お受け致しません。予めご了承下さい。

この製品を取り付け使用し、当製品以外の部品に不具合が発生しても当製品以外の部品の保証は、どの様な事柄でも一切負いかねます。

この取扱説明書は、当製品を破棄されるまで保管下さいませお願い致します。

~商品内容~

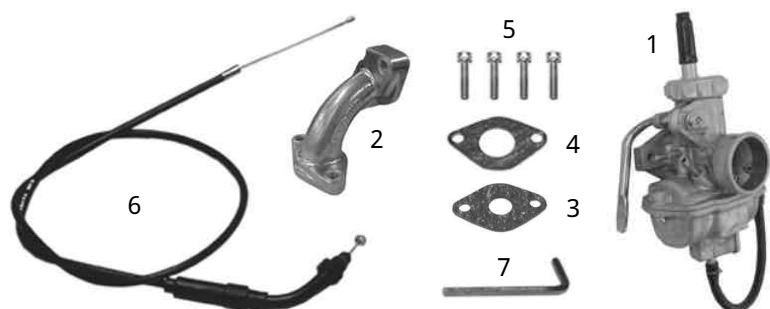

出荷時キャブレター状態

メインジェット	# 9 5
スロージェット	# 3 5
ジェットニードル	6 3 0 0 1
クリップポジション	4 段目
スロットルバルブ	# 2 0 G
エアスクリーナーオープニング	1.5 回転

番号	部品名	個数	リペア品番	入数
1	キャブレターASSY. (PC20)	1	03 03 0001	1
2	インレットパイプ	1		
3	インレットパイプガスケット	1	00 00 2343	1
4	キャブレターガスケット	1	00 03 0417	1
5	ソケットキャップスクリュー 6 X 2.5	4	00 00 0722	5
6	スロットルケーブルCOMP. (710mm)	1	09 02 0071	1
7	六角棒レンチ 5mm	1		

印はマニホールドセットの内容を示しています。

リペアパーツは必ずリペア品番にてご発注下さい。品番発注でない場合、受注出来ない場合もあります。予めご了承下さい。

尚、単品出荷出来ない部品もありますので、その場合はセット品番にてご注文下さいませお願い致します。

~取り付け要領~

セット内容をご確認ください。

(取り付け準備)

1. サイドカバーを外し、シートを外し、フューエルタンク内のガソリンを抜き取り、フューエルコックを閉じてキャブレター側のフューエルホースを抜きフューエルタンクを外します。

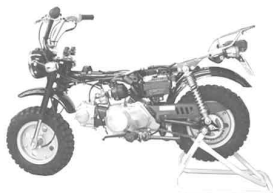

2. フューエルコックが開いていることを確認してキャブレターのドレンコックを開きフロートチャンバーからガソリンを受け皿に抜き取ります。



ドレンコック

3. インレットパイプ締め付けボルト、エアクリーナーマウントボルトを外し、エアクリーナーケース、インレットパイプごとキャブレターを取り外します。
インテークポート内に異物等が入らないよう注意して下さい。



4. スロットルバルブをキャブレターから取り外し、スロットルバルブとスロットルケーブルを分離し、スロットルケーブルからトップカバーを抜き取ります。

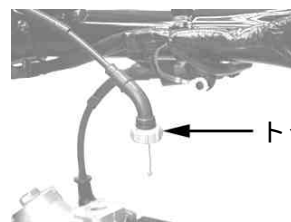

トップカバー

5. スロットルハウジングのパンスクリューを外し、スロットルケーブルを取り外します。汚れ、古くなったグリスを拭き取ります。スロットルハウジング、パンスクリューは再使用しますので小さくさないように注意して下さい。

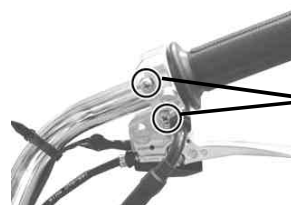

パンスクリュー

6. エアクリーナーマウントボルトでアース線をフレームに止めます。



アース線

7. 取り外した部品を袋等に入れ保管します。

(取り付け)

1. アンダースロットルハウジングにキット内スロットルケーブルを仮締めし、インナーケーブルをスロットルパイプに取り付けます。



2. スロットル摺動面にグリースを塗布し、スロットルハウジングを取り付けます。パンスクリューを締め付けます。

△注意：必ず規定トルクを守る事。

トルク：8 N・m (0.8 kgf・m)

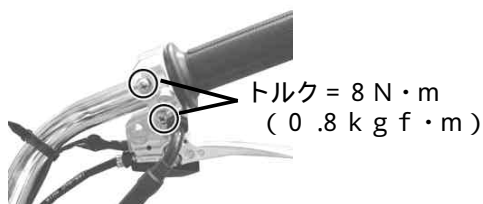

3. 付属のキャブレターのトップカバーを外しスロットルバルブスプリング、スロットルバルブを取り外します。スロットルケーブルをノーマルと同じ通し方でキャブレターまで取り回します。スロットルケーブルにキャブレタートップを取り付けスロットルバルブスプリングを圧縮した状態でインナーケーブルをスロットルバルブに取り付けます。



4. スロットルバルブの切り欠き部をスロットルストップスクリューに合わせてキャブレターに取り付けます。

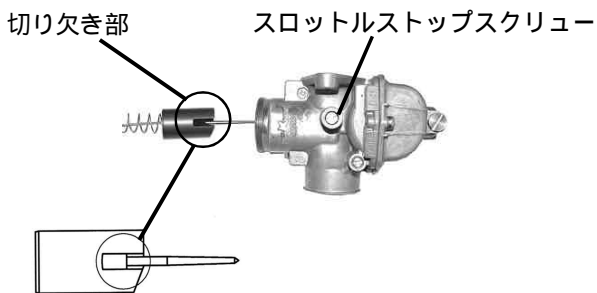

5. キャブレターとインレットパイプでキャブレターガasketを挟み、ソケットキャップスクリュー 6 × 2.5 で取り付け、規定トルクで締め付けます。

△注意：必ず規定トルクを守る事。

トルク：10 N・m (1.0 kgf・m)

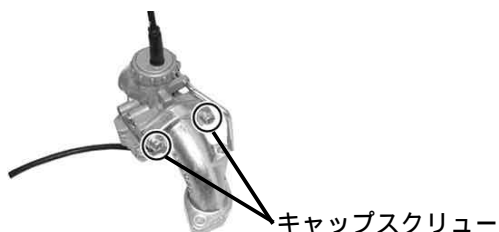

6. ワイヤーハーネスのクランプを外します。ワイヤーハーネスをキャブレターと干渉しない様にずらし固定します。シリンダーヘッドに、ガスケット、インレットパイプを順に取り付け、ソケットキャップスクリュー 6 × 2.5 を規定トルクで締め付けます。

△注意：必ず規定トルクを守る事。

トルク：10 N・m (1.0 kgf・m)

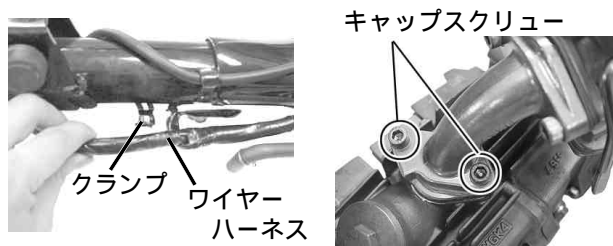

7. スロットルグリップ部で5 mm程度の遊びが出来るようにスロットルケーブルのアジャスターを調整します。スロットルを数回スナップさせ引っかかりやスロットルバルブの全開状態を確認します。ステアリングを左右にいっぱい切った状態でスロットルに遊びがある事を確認して下さい。

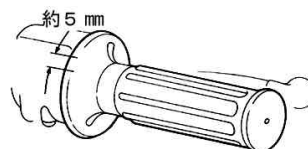

8. フューエルタンクを取り付け、シートを取り付けます。
9. フューエルコックの方向、フューエルチューブの長さを調整し、フューエルコック、キャブレターに差し込みチューブクリップを取り付けます。フューエルコックを開き各部からのガソリン漏れの有無を確認します。(コックを開いたまま長時間放置しないで下さい。)



10. チョークレバーを引きエンジンを始動させ各部からの吸気漏れの有無を確認します。チョークレバーを徐々に戻し、回転がスムーズになるまで暖機運転を行いチョークレバーを完全に戻します。エンジン暖気後アイドルリングしない場合や、アイドルリング回転数が高い場合は、スロットルストップスクリューで調整します。
11. 安全な場所で十分注意し、個々の車体に合ったセッティングを行って下さい。

スロットルパイプの加工

スタンダードスロットルハウジング使用時フレーム番号Z50J-1300017~1510400までの車両は、スロットルバルブを図に示す斜線部分をヤスリ等で削って下さい。

フレーム番号Z50J-1600008以降の車両は、加工の必要はありません。

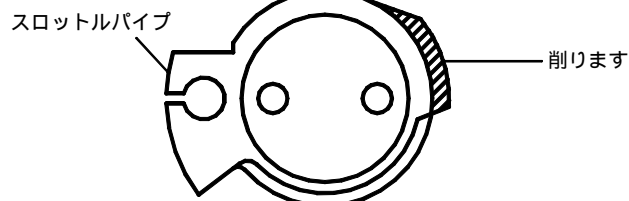

〒584-0069 大阪府富田林市錦織東三丁目5番16号
株式会社 SPECIAL PARTS 武川 TEL 0721-25-1357 FAX 0721-24-5059
URL <http://www.takegawa.co.jp>

キャブレターセッティング要領

- ・キャブレターがエンジンに適合していない時のエンジンに現れる不調の原因は、混合気が濃すぎるか薄すぎるかの2つの原因に絞られます。
- ・エンジンに現れる不調の現象は次の通りです。

混合気が濃すぎる時	混合気が薄すぎる時
<ul style="list-style-type: none"> ・爆発音が重い感じで断続する。 ・チョークを作動すると、より調子が悪くなる。 ・エンジンが暖機すると調子が悪くなる。 ・クリーナーを外すと調子が良くなる。 ・排気ガスが濃い。(黒い) ・プラグが黒くくすぶる。 	<ul style="list-style-type: none"> ・エンジンがオーバーヒート気味になる。 ・チョークを作動すると、調子が良くなる。 ・加速が悪い。(息付きをおこす) ・回転変動があり、力がない。 ・プラグが白く焼ける。

キャブレターのセッティングは暖機後に行い、走行確認を行って下さい。又、プラグは適正な熱価の物をご使用下さい。エンジン回転後、スロットル開度等により、どの範囲でエンジンが不調になるかを考慮し、下記の要領でセッティングして下さい。

ジェットニードル (スロットル開度 1 / 4 3 / 4)

加速時、スロットルに回転がついて来るか、来ないか

- ・息付きをする場合、濃くして下さい。
- ・回転の上がりが高く、排気ガスが黒い場合は薄くして下さい。

この開度での混合比は、Eリングを入れる溝の段数で調整出来ます。Eリング位置が1段目から5段目へ下がるにつれ混合気は濃くなります。

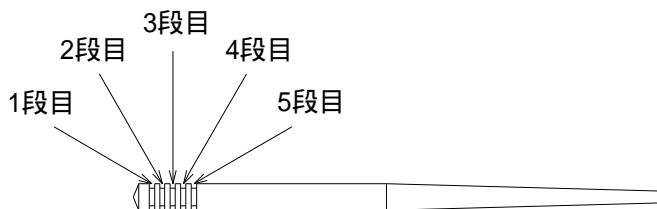

メインジェット (スロットル開度 3 / 4 4 / 4)

この開度での混合比は、ジェットの番数を変えることにより調整出来ます。番数を上げると混合気が濃くなります。仕様等を考慮の上、最高回転数(最高速度)の得られる物を選んで下さい。

パイロットジェット (調整前にもまずエアスクリューを調整して下さい。)

- ・エアスクリューの戻し量 3 .0 回転以上の場合、パイロットジェットを小さくして下さい。
- ・エアスクリューが全閉になる場合は、パイロットジェットを大きくして下さい。
- パイロットジェットはアイドルリングから低速運転時に、エンジン回転数がスムーズに立ち上がるか否かを確認します。
- ・回転上昇に谷が出来る場合、パイロットジェットが小さ過ぎます。(アイドル回転時)
- ・排気濃く排気音が重い場合、パイロットジェットが大き過ぎます。(アイドル回転時)
- ・パイロットジェット交換時には、エアスクリューの再調整が必要です。

エアスクリュー

エアスクリューはスロー系の空気流量を調整します。(アイドルリング時)

- ・エアスクリューを右に回す 混合気が濃くなる。
- ・エアスクリューを左に回す 混合気が薄くなる。

標準戻し回転数(1.5回転)に合わせ、左右に1/4 1/2回転ずつ回しエンジン回転数が最も高くなる位置に調整します。アイドルストップスクリューで安定したアイドル回転まで下げ、もう一度エアスクリューで最も回転数が高くなる位置に調整します。

気圧、気温、湿度によるセッティングへの影響

- ・高地等で気圧が下がると空気密度が下がり、キャブレターへ吸入される空気量が減少します。この為、低地で調整されたキャブレターは混合気が濃くなります。
- ・非常に気温の低い天候下では、空気密度が上がる為、キャブレターの混合気は薄くなります。
- ・雨天の場合は湿度が上がる為、空気密度が下がりキャブレターの混合気は濃くなります。

性能アップ、デザイン変更、コストアップ等で商品および価格は予告無く変更されます。あらかじめご了承下さい。

クレームについては、材料および加工に欠陥があると認められた商品に対してのみ、お買い上げ後1ヶ月以内を限度として、修理又は交換させて頂きます。但し、正しい取り付けや、使用方法など守られていない場合は、この限りではありません。修理又は交換等にかかる一切の費用は対象となりません。

この取扱説明書は、本商品を破棄されるまで保管下さいませお願い致します。

株式会社 **SPECIAL PARTS 武川** 〒584-0069 大阪府富田林市錦織東三丁目5番16号
 TEL 0721-25-1357 FAX 0721-24-5059 URL <http://www.takegawa.co.jp>
 お問い合わせ専用ダイヤル 0721 25 8857