

FI Con 2 manual

for MSX125 (Thailand model) Super head 4V + R (Big throttle response)

Product number 05-04-0024

Applicable model MSX125(Thailand specification)

Thank you for your purchase of our product.
Please so you will comply with the following matters at the time of use.
Please check your always kit contents before mounting. If there is a point of notice, please consult the dealer of purchase.
If the description, such as photos or Illustration different with this part.

■ Characteristic

This compact controller already has preset data for several engine parts. Injection controller which can be changed the settings easily by switching the rotary switch of the main body. Built-in maps of the fuel injection, can be increased or decreased slightly by simply turning the rotary switch. ■ Upper limit number of revolutions will also be about 11500rpm exceeding the genuine ECU.

● Please read carefully before use.

- The use ignoring the instructions that are written in the manual, if the accident or damage has occurred, we can not assume any responsibility for compensation.
- If trouble occurs in the other components with the use of this product are attached to, other than this product parts warranty, we also can not assume any in any such matters.
- When it is machining like the products and mounting, do not covered under warranty.
- Please refrain from inquiries about the product and the combination of other companies.
- This product is a dedicated products of the type of vehicle. Please note that you can not in other vehicle mounting.
- Please apply at the repair part number if attached to repair parts. If you have any questions, please contact your purchased dealer.
- We are confirm the operation at MSX125(MLHJC6181D50 *****) are sold in Thailand specification.
Even MSX125, operation to the other specifications of the other destination is unknown.

● Precautions on usepurchased dealer.

For can not be combination parts.

In many cases, HID kit of goods outside the company you get a high-voltage noise that adversely affect the ballast / inverter (voltage conversion device) to a digital circuit. It will be the cause of product failure or malfunction, please do not installed simultaneously absolutely.

Ignition system of goods outside the company (ignition coil and plug cord) is associated with the up of the ignition voltage, please do not use it can cause malfunction or failure of the product due to the increase of radiation noise. However, simultaneous mounted possible with our LED headlight kit.

The power generator of goods outside the company due to differences in shortages and voltage waveform of the power generation amount, it will be the cause of failure, please do not use.

◎ Since this product is not waterproof and drip-proof structure, and take a rain or water, water might fail to penetrate into the body. Please be careful when the car wash likewise. Please immediately stop the use if the water has entered the body. When the switch part of attached to using a panel of transparent, the humidity is high, suddenly there are a change in temperature, etc. the body it may cloudiness occurs in the transparent part of the panel to inhale moisture.

◎ Product of the body is made of resin. Use cover, etc. If in order to prevent deterioration long time to put the motorcycle on the field. When long-term left for under harsh conditions such as in a hot weather, it is considered the deterioration and deformation of the resin and rubber parts.

◎ Please do not disassemble. In addition, Please note if it is decomposed by the customer, we will not be able to accept the inspection and repair.

◎ Please do not give a heavy shock. Do not performed a strong shock is transmitted to this product. Unrepairable and failure due to fall off or disconnection of the internal parts by the impact, and there is a risk of the main body case damage.

◎ On cleaning. Dissolve a small amount of neutral detergent in the water if there is tough dirt, please slowly carefully dirt. Please note, the use of volatile certain things (thinner, alcohol, etc.) and compounds, possibilities and alteration of the resin part, panel will cloudy.

! NOTE When the handling of ignoring this display, property damage and human shows the assumption of what injury.

- In the public roads, please try to law-abiding operation protect the legal speed.
- When performing the work, etc., be sure during the cold (when the engine and the muffler is cold). (It may cause burns.)
- When performing the work, it should be made to prepare the tools for the job. (Breakage of parts, it may cause injury.)
- Do the work must always specified torque using a torque wrench. (Damage of bolts and nuts, and cause of dropout.)
- The product and the frame, might have edges or protrusions. Please go to protect your hands when you work. (It may cause injury.)
- Be sure to each part inspection before operation, check the loosening of the threaded portion, be sure to securely tighten the specified torque if there is loose. (It may cause detachment of the parts.)

! Warning When the handling of ignoring this display people died, shows the contents of the serious injury possibility is assumed.

- During operation, when an abnormality occurs, immediately stop the vehicle in a safe place, please stop running. (It may lead to an accident.)
- When performing the work, do the work safely stabilize the vehicle in a horizontal location. (There is a risk of injury vehicle collapsed while working.)
- Inspection, maintenance, the instruction manual or, inspection methods such as service manuals, to protect the way, should be done correctly. (unsuitable inspection and maintenance, there is a risk that result to an accident.)
- When carrying out the inspection and maintenance, etc., if found damaged parts, replace the damaged parts to avoid possible to reuse the parts. (There is a risk that lead to accidents Continued use.)
- Plastic bags of product packaging, you can either be stored in a place that is out of reach of children, it should be discarded. (When the children or wearing, there is a risk of suffocation.)

- Please note. Performance up, the design change, the product and the price in the cost up, etc. are subject to change without notice.
- For claims, only to products that have been recognized to be defective in material and processing, to the extent within one month after purchase, we will repair or replace. However all of the cost of such exchange fees are not eligible.
Correct installation and, if it is not protected, such as how to use, it does not have this limitation.
Please note. If you use in the race, etc., in any case the claim can not be accepted.
- Until it is destroying the product, please keep this manual.

SPECIAL PARTS
TAKEGAWA

CONTACT Address : 3-5-16 Nishikiorihigashi Tondabayashi Osaka JAPAN
TEL: +81-721-25-1357 FAX: +81-721-24-5059 e-mail: english@takegawa.co.jp URL http:// www.takegawa.co.jp
Please contact with your name and country name provided. (Only English please)

Product content

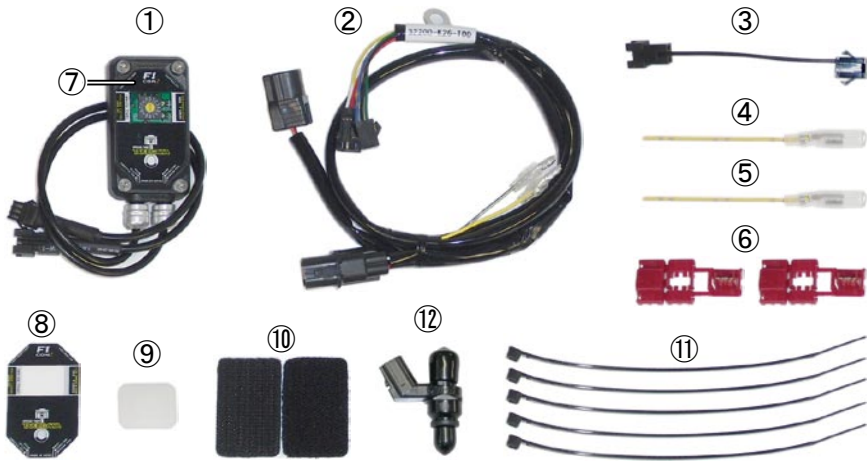

Part Names

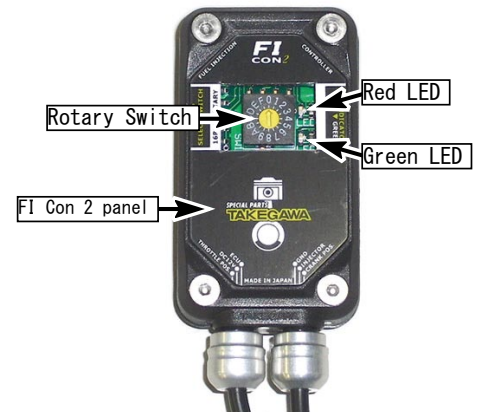

Number	Product content	Quantity	Item Number
1	FI CON 2 Assy.	1	—
2	Harness Comp.	1	32200-K26-T00
3	Restore harness Comp.	1	38772-FC3-T00
4	Subcode (BL/YEL)	1	32231-C03-T00
5	Subcode (YEL)	1	32231-C02-T00
6	Electro tap	2	00-05-0015 (5 pcs)
7	FI Con 2 panel (switch unit opening hole)	1※	38775-FC3-T00
8	FI Con 2 panel (switch unit clear)	1	38775-FC3-T00
9	Rubber cap	1	00-05-0045
10	Velcro tape	1	00-00-0150
11	Cable tie 150mm	5	00-00-0135 (10 pcs)
12	Fuelinjector Assy.	1	00-00-0487

※ 7. FI Con 2 panel (switch unit opening hole) is, 1. FI Con 2 Assy. To the factory pasted already.
 ※ Please note. Please order in the repair parts are always repair part number. If it is not the part number order, you may not be able to order.
 It should be noted, In the case of parts that can not be separately shipment, please order a set part number.

■ Mounting procedure ※ With regard to the mounting method and the specified torque of detail, refer to the genuine service manual.

■ Introduction

This product has been developed on the assumption that the genuine PGM-FI system is operating without problems. If the PGM-FI system itself there is trouble and upset, it may not work if it is installed the product correctly, not only can not exhibit the performance, it does not could lead to failure is beginning elsewhere this product. Be sure to check that there is no trouble in the PGM-FI system, should be attached and use. In addition, work by using a maintenance stand like a horizontal a safe place, start then fully stabilized to the vehicle.

■ Removal of exterior parts and others.

▲ NOTE

Exterior parts removal work at our instruction manual, we have noted the only summary that omits the details. If you are unfamiliar with the work, you should better to request it to a shop. Or please be sure to work in accordance with the work procedure of the manufacturer original service manual. Also at the description of covers, be careful not to damage the holding pin part and groove part.

① Remove left and right shroud (referring to the genuine service manual).

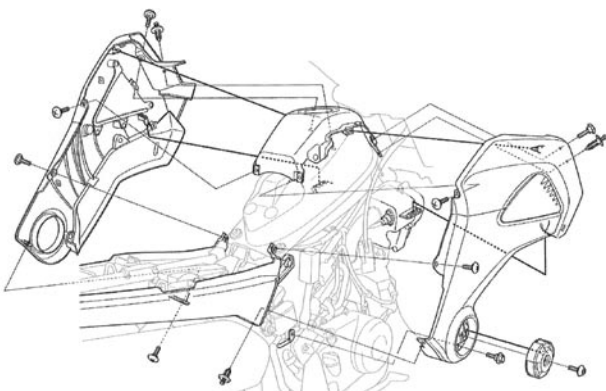

② Disconnect the negative terminal of the battery.

■ Replacement of the fuel injector

If you are attached our company made big throttle body kit at the same time, please refer to the instruction manual of the big throttle body kit. If you use a genuine throttle body kit, referring to the genuine service manual and replace it with a fuel injector of the fuel injector comes in the kit.

① Disconnect the fuel injector 2P coupler.

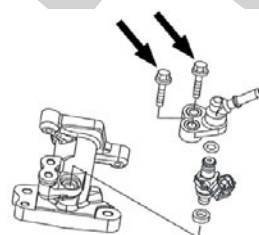

② Disconnect the fuel pressure, from the intake pipe, remove the two fuel injectors joint mount bolts. And remove the genuine fuel injector and fuel injector joint.

③ In reverse order of removal, it will Install the fuel injector kit.

▲ NOTE

Be sure to protect the specified torque.
 Torque: 12N · m (1.2kgf · m)
 It does not remove the quick connector of the fuel line. But it works as hose is not bend.

▲ Warning

Gasoline is extremely flammable, those that are flammable to avoid any fire make sure that there is no around. In addition, the residence of the vaporized gasoline there is a danger of explosion, etc., to work in well-ventilated areas.

■ FI con 2 for MSX125 (Thailand model)

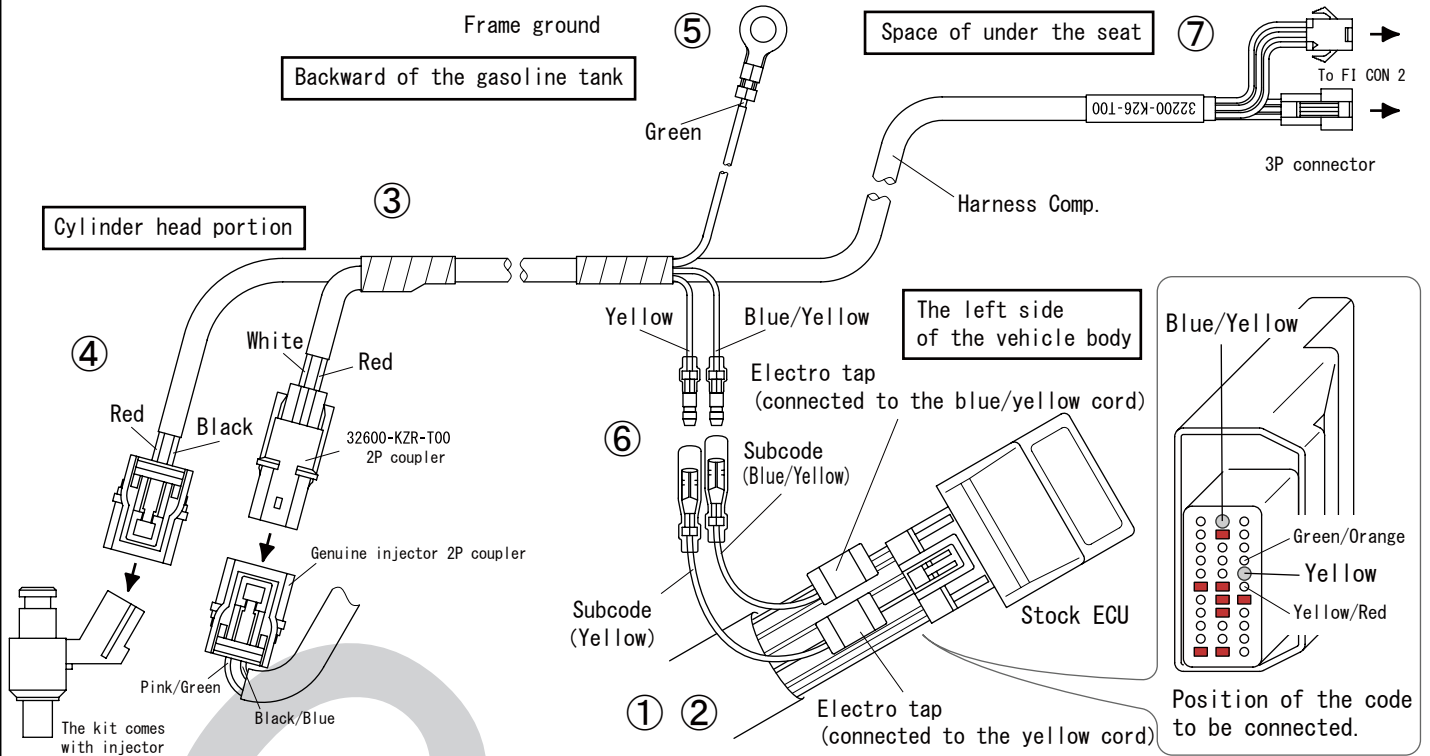

In order of the number in figure, do the work while checking the annotation.

▲ NOTE

Cord color notation in this manual, that means base color / line color. "blue / yellow" means the cord that contains the yellow line to the blue cover.

① Connect sub cords of "blue / yellow" and "yellow" included in a kit with electro tap into the same color cord of the main harness.

▲ NOTE

There are two yellow cords in main harness. Should be connected to the yellow cord between green/ orange and yellow/red.

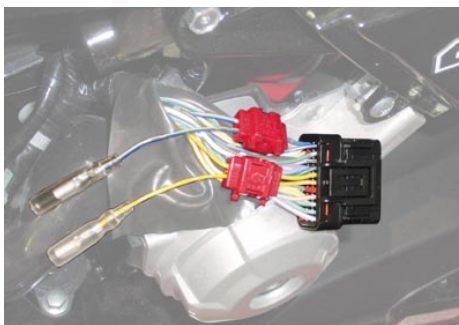

② Please put the electro tap part in the stock harness cover as much as possible and restored to securely connect the connector to the genuine ECU.



③ Put 2P connectors of the harness Comp. in a kit to the rear of the vehicle along with the main harness of the left side of the vehicle body surface to be able to connect to the stock injector connector.

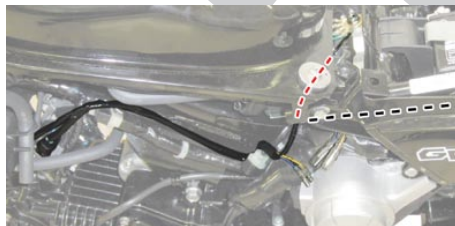

④ Disconnect the 2P coupler of the stock injector, and then connect to 2P coupler of the harness Comp. which has the marking of 32600-KZR-T00. The harness Comp of 2P coupler (those that have come up with a red, black code), it will be connected to the injector of this kit.



⑤ Fasten the round earth terminal for the frame ground together with the stock earth point behind the gasoline tank.

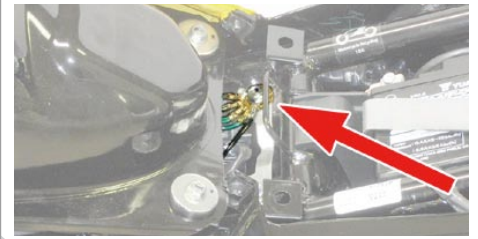

⑥ Connect those male terminal of Blue/Yellow code and Yellow code of harness Comp. to the same color of female terminal of sub-harness.

⑦ Pass the 2 kinds of 3P connector of harness Comp. through the top of genuine ECU to the side of battery under the seat.

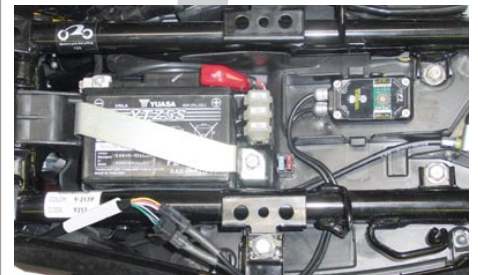

⑧ Connect 3P connectors of FI CON2 with 3P connectors of harness Comp.

▲ NOTE

Please be careful not to tuck the harnesses at the time of attaching the seat.

After the connection, make sure there is no mistake in wiring. And then connect the negative terminal of the battery if there is no problem.

■ Initial setting of the throttle position sensor/ MAP type selection

At the first time after installing the FI CON2 or when you adjusted the throttle body stopper screw (screw to adjust the fully closed position), it is necessary to set the throttle position sensor again.

Also, if you want to change the MAP by changing the engine specifications, please re-set in accordance with the following procedure.

- ① Turn off the key and then set the rotary switch to "0". Throttle grip should be fully closed.

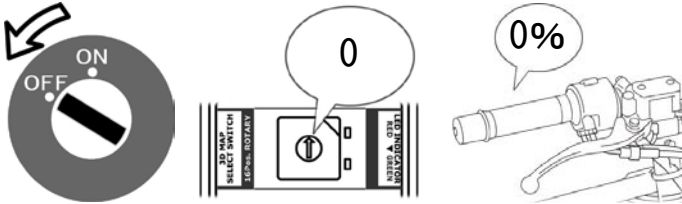

- ② Turn on the key. Red and green LED light on at the same time. After the red flashes two times, and then both red and green will light off. Then, green LED will begin to flash.

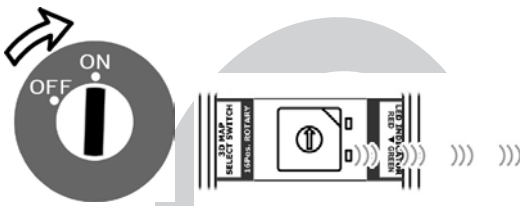

- ③ Remains in this state, set the rotary switch to the suitable SW number by engine specifications. Please refer on page 7, "MAP Selection Table by engine specification".

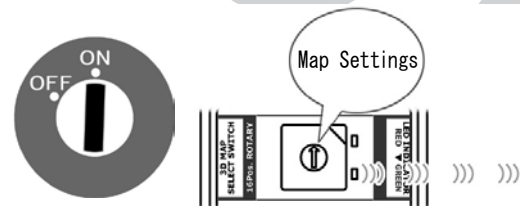

- ④ Slowly fully open the throttle grip, keep fully open for more than 1 second, and then slowly fully close it.

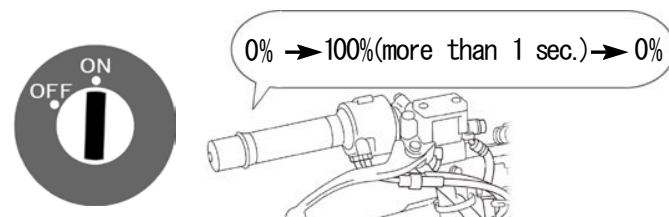

- ⑤ After fully closed, green LED stops flashing and it will remain off. When the green LED turned off, it can be learned successfully the setting of throttle position sensor and the selection of MAP type, to the internal memory of the FI CON2. Even exchange the battery or turn the key OFF, learning contents won't be deleted.

▲ NOTE

When the grip is fully closed again, if the green LED is continuously flashing, connection failure of yellow sub-code can be considered, or may be kept it fully opened for too short.

- ⑥ Turn the key off and then set the rotary switch to "5".

▲ NOTE

Function of rotary switch of FI CON2, after the MAP selection and learning will be the adjustment of correction value. After the initial setting, first should be set "5" (standard setting).

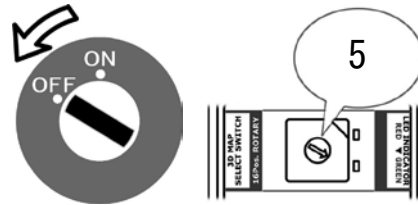

■ Setting of MAP of increase or decrease adjustment.

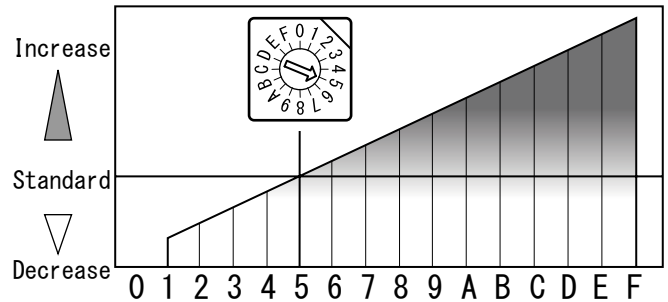

FI CON2 to match the vehicle individual differences and preferences, can be adjusted the correction value of the selected MAP by changing the rotary switch. "5" is the standard value of our setting, and more the number is smaller, the amount of fuel injection value will be decreased. More the number is bigger, the amount of fuel injection value will be increased. However, "0" is for the initial setting. If set to "0", engine will be stopped.

The adjustment of the fuel correction to increase or decrease the whole rpm range. Too large numbers can be the cause of not to idle. Also it can be cause of bad engine setting at a specific rotation speed range. Unless specifically required, please set the standard setting "5".

Can be adjusted at the time of engine idling or key OFF.

▲ Warning

Because it is very dangerous, do not change it while riding. It may cause a serious accident.

■ Operation check

▲ Warning

When you check the engine setting after the engine started, always should be done in a well-ventilated place. Do not start the engine in an airtight place. (You will suffer from carbon monoxide poisoning.)

▲ NOTE

If it is different from the LED lighting pattern noted below, it will be considered, such as the failure of the wiring and learning setting. In accordance with the contents of the troubleshooting of end of this manual, please check each part.

■ Confirmation of selected MAP

Rotary switch of FI CON2 shows the fine adjustment amount of selected MAP. Therefore, just by looking at the rotary switch, it is unable to determine which MAP is currently selected. Can be confirm the selected MAP by the following method.

- ① Key OFF, and then hold the throttle fully open position.
- ② While retaining the full throttle position, and turn the key ON.
- ③ Red and green LED lights at the same time, the green LED flashes two times, and then both red and green goes out. Then, only the green LED will start flashing. After this, you can release the hand from the throttle.
- ④ Flashing pattern is showing the selected MAP.

Check the flashing pattern, and confirm the selected MAP.

There are two types of lit. Long lit (about 0.7 seconds) and short lit (about 0.2 seconds). Long lit indicates the tens digit.

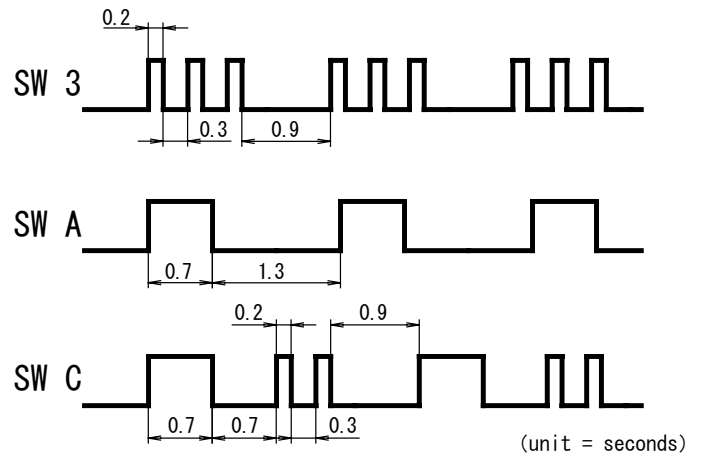

Example display

MAP selection 3 ... iteration of three short lighting

MAP selection A ("10" as a decimal number.)

... iteration of a long lighting ((It looks slow flashing.))

MAP selection C ("12" as a decimal number.)

... iteration of one long lighting and 2 short lighting.

- ⑤ Key OFF. In addition, can not be start the engine during the green LED flashes. Start the engine after the key OFF.

■ Operation check

- ① While viewing the LED of FI CON2, turn on the key.
Red and green LED lights at the same time, the green LED flashes two times, and then both red and green goes out.
- ② After starting the engine, if FI CON2 is working correctly, then green LED lights up.
In addition, while the engine speed exceeds the genuine upper limit rotation speed, the red LED will also be illuminated.

■ Attachment of exterior parts and others

Please be careful not to tuck the harnesses at the time of attaching the exterior and others.

▲ NOTE: Be sure to follow the specified torque written in genuine service manual.

■ About rubber cap and the panel

When performing the setting of the FI Con 2, remove only the rubber cap when turning the rotary switch.

▲ NOTE

When operation without a rubber cap, it may cause dust and water to failure penetrated FI Con 2. During operation to attach the rubber cap always, or please attach the panel described later.

When setting the need for is no longer, from a panel of default at the time of the switch unit hole opening of FI Con 2, please recovered in a clear panel attached to the kit. Then improved dust-proof and drip-proof performance, has the effect of preventing the unnecessary trouble.

▲ NOTE

When you paste the panel, in the concave 8 corners of the FI Con 2 top, please paste it into accurate. When would ride the panel to edge portion is displaced from the concave, such as dust or water penetration from the gap, it will cause the FI Con 2 fails.

■ About a restore harness Comp.

By connecting the supplied restore harness Comp. to the 3P connector of harness Comp. instead of the FI CON2 Comp. , can be returned to the fuel injection control in easily genuine ECU even without removing the exterior kind.

When you intend to use the FI CON2, be sure to carry this at all times.

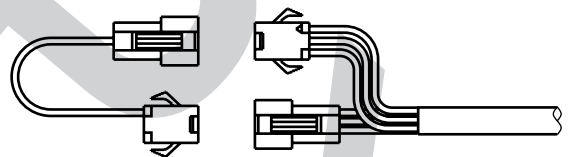

▲ NOTE:

Do not connect to each other of the 3P connector of harness Comp. directly.

It may cause genuine ECU damage.

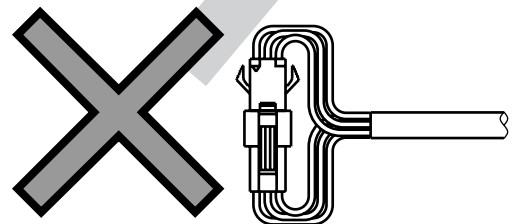

■ MAP Selection Table by engine specification

Each parts other than the stock parts in a following setting table are all limited to TAKEGAWA parts.

At the initial setting, set the rotary switch to the suitable SW number by engine specifications.

Please note, only is the setting that made the test at our company. vehicle individual difference and the outside air temperature and altitude, rider of body weight, due to an external factor, it might not necessarily be in the best setting.

SW No.	Engine specifications.
0	—
1	Genuine throttle body + Genuine air cleaner box + Power Silent Oval Exhaust System (Full Exhaust System)
2	Genuine throttle body + Genuine air cleaner box + Cone Oval Exhaust System (Full Exhaust System)
3	Genuine throttle body + Genuine air cleaner box + Bomber Exhaust System (Full Exhaust System)
4	—
5	—
6	—
7	—
8	—
9	Big throttle body + Genuine air cleaner box + Power Silent Oval Exhaust System (Full Exhaust System)
A	Big throttle body + Genuine air cleaner box + Cone Oval Exhaust System (Full Exhaust System)
B	Big throttle body + Genuine air cleaner box + Bomber Exhaust System (Full Exhaust System)
C	—
D	Big throttle body + Air filter kit + Power Silent Oval Exhaust System (Full Exhaust System)
E	Big throttle body + Air filter kit + Cone Oval Exhaust System (Full Exhaust System)
F	Big throttle body + Air filter kit + Bomber Exhaust System (Full Exhaust System)

※ Everything is the premise installation of our company made Super head 4V + R (181cc) + cam shaft (10 / 10D).

※ Genuine Exhaust system and Cone oval Exhaust system (slip-on type) does not fit.

※ Genuine air cleaner box specifications, even in genuine filter element, you can use either of our power filter (03-01-0001).

※ Air filter kit specifications, our air filter kit (03-01-0004) will be dedicated.

※ In the above table, “—” means no data is set. So please do not set that number to SW.

■ About an adjustment of idling speed (Ref)

- Start the engine, and warm-up for 20 minutes.
- Measure the engine idling speed.
- If the idle speed is out of specification, turn the idle air screw shown in the left side throttle body diagram arrow, please adjust to the idling speed of the specified.
- The case of genuine throttle body about 1800rpm ~ 2000rpm
- The case of our company made big throttle body about 2000rpm ~ 2200rpm



▲ NOTE

When you turn the idle air screw, please make a note how much turned from genuine position so that can be returned to original position. Please adjust little by little, do not rotated 1/4 turn (90 degrees) or more at a time. Also, after adjusting the screw, please idling the engine for 10 seconds or more until the engine speed becomes stable, and then measure the engine speed again.

■ Reference

It is assumed that the engine has been assembled correctly.

If the idling is not sustained at the time of the first start-up after assembly, turning in the direction of loosening the idle air screw, which may be idle.

■ Troubleshooting

Even in key ON, LED is also not lit or flashing.	<ul style="list-style-type: none"> ■ Make sure the kill switch is not set to OFF. ■ FI CON2 might not come power supply to the body. Please check the battery voltage of the red cord of harness Comp. 3P connector at key ON. ■ Make sure the round earth terminal of the green cords are securely connected to the frame ground.
At the key ON, both LED remains lit.	<ul style="list-style-type: none"> ■ It is a state that has not been the initial setting of the throttle position and MAP selection. Please do the initial setting.
Engine does not start.	<ul style="list-style-type: none"> ■ Please re-confirm the wiring connection of harness Comp. connector. ■ If the initial start-up, make sure the rotary switch indicate "5".
Upon the key ON, it remains only one of the red LED or the green LED is lit.	<ul style="list-style-type: none"> ■ It is a state that is not normally read the throttle opening signal. Make sure there is no problem with the connection of the yellow code. ■ The main harness has two yellow code. Always and green / orange code, should be connected to the yellow of code that is between the yellow / red code.
After the engine is started, the green LED does not lit.	<ul style="list-style-type: none"> ■ It is a state that is not read successfully the crank pulse. Make sure there is no problem with the connection of the sub-code (blue / yellow).
After the engine is started, the green LED lit, but sometimes not lit.	<ul style="list-style-type: none"> ■ At the engine start, if turning on the starter motor while snapping the throttle, it might become such symptoms. Please start the engine without snapping the throttle.
Feel like setting does not match.	<ul style="list-style-type: none"> ■ Make sure the MAP that matches the engine specifications have been correctly selected. ■ Setting of rotary switch during engine operation, rather than a MAP number, make sure that indicates standard setting of "5". ■ The combination of engine parts other than TAKEGAWA, probably not match the setting, it may become a cause of idling malfunction or engine stall.

COPY